



Aircore EC Motor

IES150-5HP-2400RPM

Datasheet

Ordering Information

Catalog Number	IES150-5-2400-460-A Note: See Control Connections
Catalog Number	IES150-5-2400-460-C Note: See Control Connections
Catalog Number	IES150-5-2400-460-(A/C)-H Note: See Mechanical Below

Motor Information

Rated Power	5 HP, 3.73 kW
Rated Torque	15 Nm, 11.1 ft-lb
Rated Speed	2400 rpm
Max Speed	2880 rpm
Min Speed	100 rpm
Weight (Motor and Drive)	93.2 lbs, 42.3 kg
Frame Diameter	16.18", 41.1 cm
Length (Motor and Drive)	9.4", 23.9 cm
System Efficiency	88.0%
Duty Cycle	Continuous
Variable Speed	Yes, Integrated VFD
Service Factor	1.0
Motor Thermal Protection	Electronically-Protected L
Motor Type	TEFC
Enclosure Rating	IP54

Electrical

Supply Voltage	460 VAC \pm 10%
Supply Phase	3 Phase
Supply Voltage Frequency	60 Hz \pm 5%
Voltage Imbalance	\pm 3% Phase to Phase Voltage
Short Circuit Current Rating (SCCR)	Input - 5 kA, 500 V maximum
Rated Amps	6.0 A (460 VAC)
Motor Insulation Class	B

Aircore EC Motor

IES150-5HP-2400RPM

Datasheet

Performance



Mechanical

Direction of Rotation	CW/CCW
Motor Frame Material	Aluminum
Rotor Inertia	0.49 kg/m ²
Bearing Type - DE	Standard: Steel, 6206 sealed, Permanently Lubricated Optional: Hybrid Ceramic (-H in Catalog Number)
Bearing Type - NDE	Standard: Steel, 6206 sealed, Permanently Lubricated Optional: Hybrid Ceramic (-H in Catalog Number)
Grease Specification	Mobil Polyrex EM
Regreasable	No
Grounding Brushes	Included - DE
Shaft Design	Keyed
Motor Mounting Position	Horizontal or Vertical (Shaft Down)
Motor Mounting Type	C-Face (182TC) and Body Mount

Ambient Operating Conditions

Condition	Operation	Storage & Transportation
Altitude	0 to 1,000 m (3,300 ft.) above sea level 9% power derate per 1,000 m up to 4,000 m	NA
Air Temperature	-25 to 40 °C (-13 to 104 °F)	-40 to 85 °C (-40 to 185 °F)
Relative Humidity	95%, No condensation allowed	95%, No condensation allowed
Contamination Levels	No conductive dust allowed	No conductive dust allowed

Aircore EC Motor

IES150-5HP-2400RPM

Datasheet

Mounting Information

Below are the basic measurements needed for installation tasks.

- There are four mounting pad locations.
- Each pad is spaced 90° apart, containing 4 mounting holes and one lifting eye hole.
- This design accommodates many different installation arrangements.

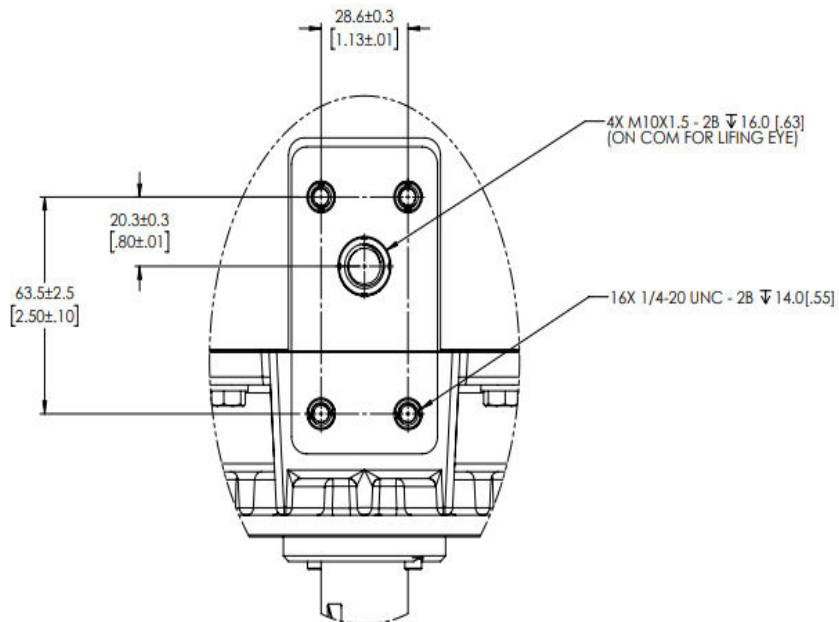
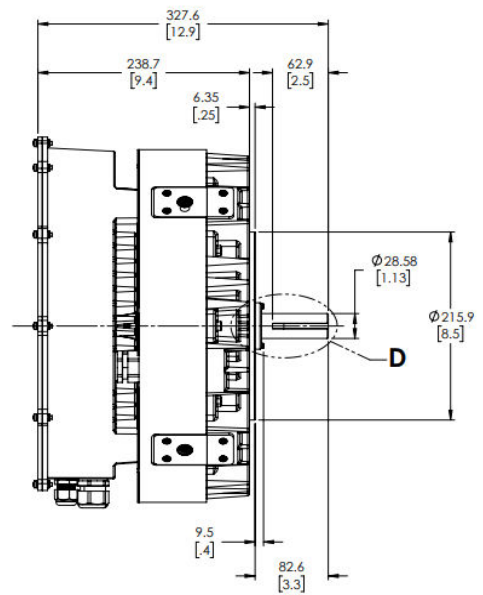
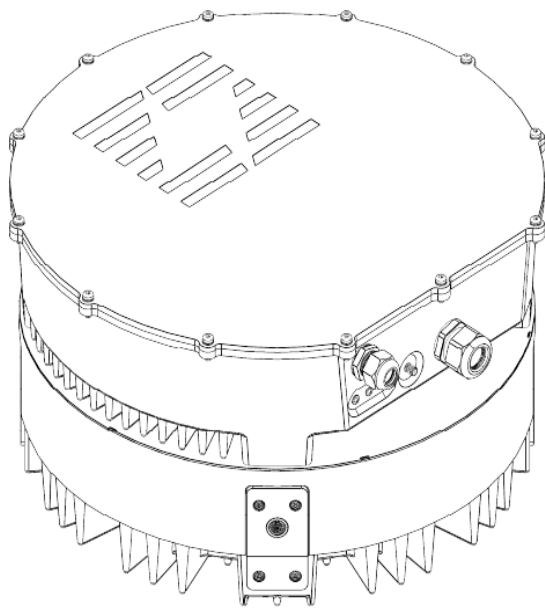

Aircore EC Motor

IES150-5HP-2400RPM

Datasheet

- The DE face of the mounting block has threaded holes for four bolts (1/2"-13).
- All bolt holes should be used for secure mounting of the motor to equipment.

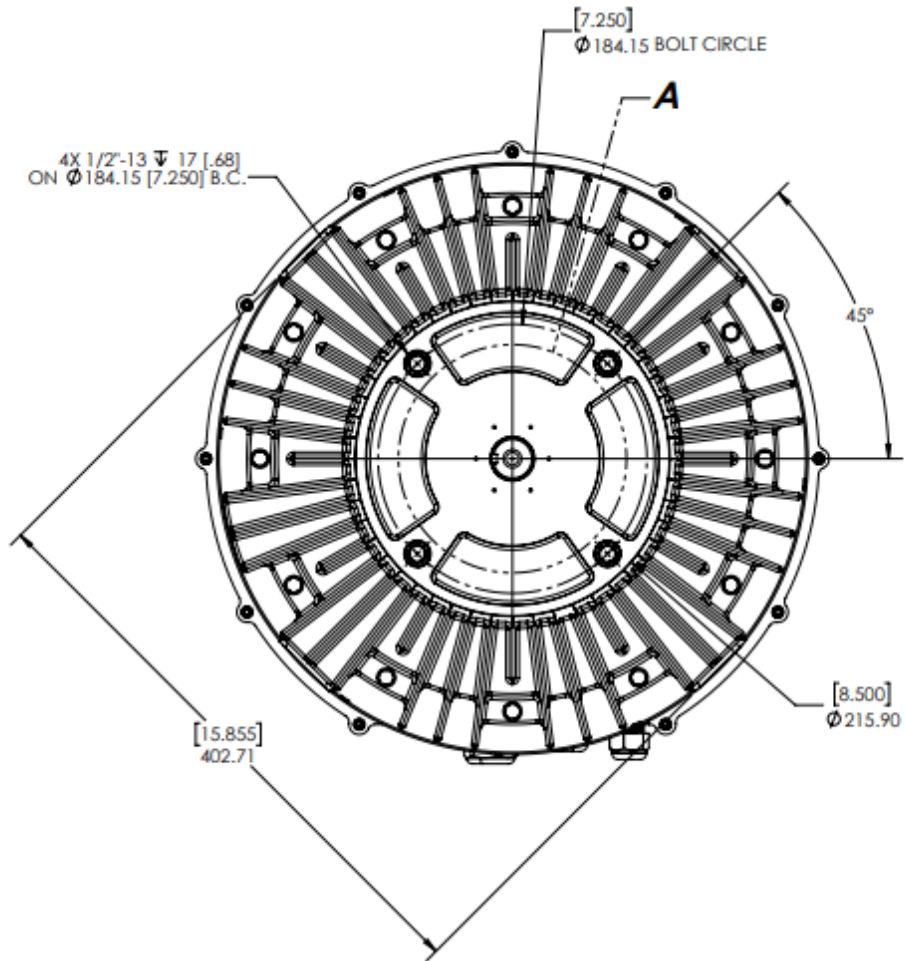

- Shaft and keyway dimensions:

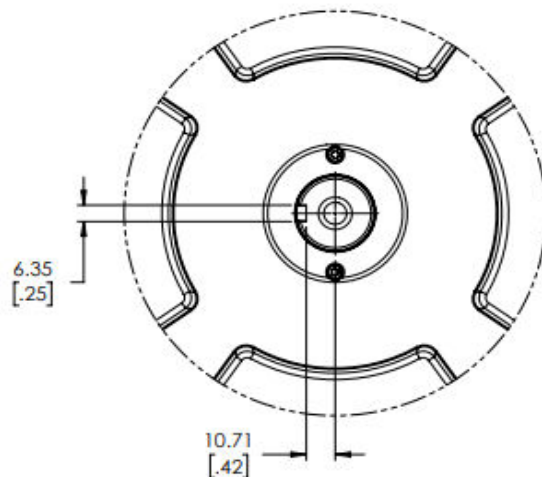

Aircore EC Motor

IES150-5HP-2400RPM

Datasheet

Control Connections

The IEs User Manual has graphics showing locations of the following Inputs and Outputs.

Note: The letter at the end of the Catalog Number indicates supported VFD Inputs and Outputs

- **A motors support all the I/Os listed below**
- **C motors do not support Analog Outputs**

Description	Quantity	Type
Analog Input Software selectable for voltage or current input	1	<ol style="list-style-type: none"> 1. Voltage Signal – 0 to 10 VDC, Rin = 20 kΩ 2. Current Signal – 0 to 20 mA, Rin = 500 Ω 3. Resolution – 0.1% 4. Accuracy - ± 5%
Analog Output (See Above) Software selectable for voltage or current output	1	<ol style="list-style-type: none"> 1. Voltage – 0 to 10 VDC with 10 mA maximum 2. Current – 0 to 20 mA with load < 500 Ω
Auxiliary Voltage	1	<ol style="list-style-type: none"> 1. 24 VDC User Supply with ±5% with 250 mA maximum
Digital Input	4	<ol style="list-style-type: none"> 1. 24 VDC with internal or external supply 2. Input impedance – 1 kΩ
Digital Output	2	<ol style="list-style-type: none"> 1. Open drain output 2. Maximum Switching Voltage 40 VDC 3. Maximum Switching Current 350 mA
Relay Output	1	<ol style="list-style-type: none"> 1. Normally Open (NO), Normally Closed (NC) contact arrangements 2. Maximum Switching Voltage of 125 VAC/30 VDC 3. Maximum Switching Current of: <ol style="list-style-type: none"> a. NO – 10 A (VAC)/5 A (VDC) b. NC – 3 A (VAC)/3 A (VDC)
EIA-485 Interface for Modbus RTU	1	<ol style="list-style-type: none"> 1. Shielded twisted pair cable with impedance of 120 Ω 2. Transfer rate of 19200 baud 3. Half duplex Modbus communication protocol

Regulatory

UL 1004-7	Standard for Electronically Protected Motors
UL 1004-1	Rotating Electrical Machines – General Requirements
CSA C22.2 No.77	Motors with Inherent Overheating Protection
UL 61800-5-1	Standard for Adjustable Speed Electrical Power Drive Systems, Part 5-1: Safety Requirements & Electrical, Thermal and Energy



106 Old Settlers Blvd
Suite D106
Round Rock, TX 78664

info@goinfinitum.com
goinfinitum.com
support.goinfinitum.com

We reserve the right to make technical changes or modify the contents of this document without prior notice. Copyright© 2022 Infinitum Electric, Inc. All rights reserved.